

1. PROVIDE ONE GFI 120VAC 15A OUTLET CLOSE TO THE BACK OF TOWER ONLY IF A MIN 24" ACCESS WAY IS AVAILABLE, OTHERWISE COORDINATE WITH LIFT INSTALLER
2. PROVIDE ALSO ONE WIRE AT THE SAME PLACE 120VAC, 15A
3. ENSURE AN ADEQUATE LIGHTING FOR THE VEHICLE AND THE LANDING BY ELECTRICIEN

RUNWAY MUST BE SMOOTH AND EXTEND 12" MIN. ON EACH SIDE OF LANDING GATE. OTHERWISE, EXTEND ON ALL AVAILABLE AREA. (SEE DETAIL "A"). BY GENERAL CONTRACTOR

1 VISTA-613-AB 36x60 (WITHOUT HELPER)

- NOTE**
1. PROVIDE 100 lx MIN. LIGHTING TO THE WHOLE PLATFORM (BY ELECTRICIAN).
 2. ANY WALL LOCATED LESS THAN 12" (WITHOUT HELPER) OR 24"(WITH HELPER) AWAY FROM THE CAB MUST EXCEED THE UPPER LANDING HEIGHT BY AT LEAST 42". IT MUST BE SMOOTH (NO RECESSES OR PROTRUSIONS).

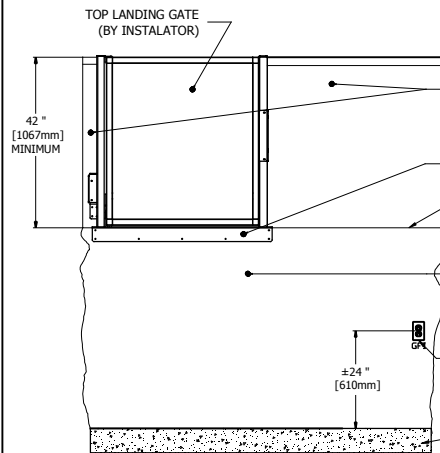

2 DETAIL B SIDE VIEW

NOTE
LIFT NOT SHOWN, IN ORDER TO CLARIFY THE DRAWING.

- UPPER LANDING SIDE RAILINGS, WITHOUT OPENINGS. TO BE INSTALLED AFTER THE LIFTING PLATFORM IS IN PLACE. THEY MUST BE ABLE TO HOLD THE LANDING GATE ASSEMBLY. BY GENERAL CONTRACTOR.
- LANDING GATE SILL
- TOP LANDING
- RUNWAY MUST BE SMOOTH AND EXTEND 12"(WITHOUT HELPER) OR 24"(WITH HELPER) MIN. ON EACH SIDE OF LANDING GATE. OTHERWISE, EXTEND ON ALL AVAILABLE AREA. (SEE DETAIL "B"). BY GENERAL CONTRACTOR
1. PROVIDE ONE GFI 120VAC 15A OUTLET CLOSE TO THE BACK OF TOWER ONLY IF A MIN 24" ACCESS WAY IS AVAILABLE, OTHERWISE COORDINATE WITH LIFT INSTALLER
 2. PROVIDE ALSO ONE WIRE AT THE SAME PLACE 120VAC, 15A. BY ELECTRICIEN
- 6" CONCRETE SLAB MIN 25 MPa

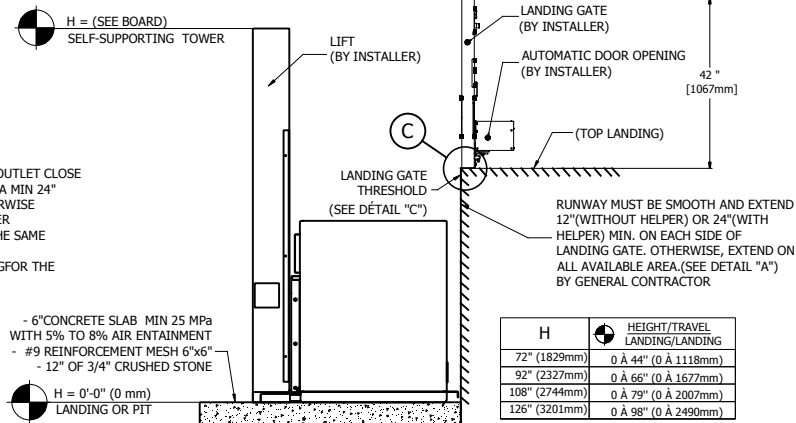

3 DETAIL A FLOOR ELEVATION

- 6" CONCRETE SLAB MIN 25 MPa WITH 5% TO 8% AIR ENTRAINMENT
 - #9 REINFORCEMENT MESH 6"x6"
 - 12" OF 3/4" CRUSHED STONE
- H = 0'-0" (0 mm)
LANDING OR PIT

H	HEIGHT/TRAVEL	LANDING/LANDING
72" (1829mm)	0 À 44" (0 À 1118mm)	
92" (2327mm)	0 À 66" (0 À 1677mm)	
108" (2744mm)	0 À 79" (0 À 2007mm)	
126" (3201mm)	0 À 98" (0 À 2490mm)	

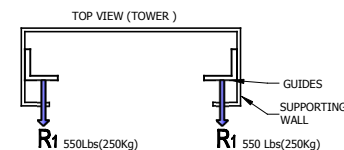

5 RAIL REACTIONS

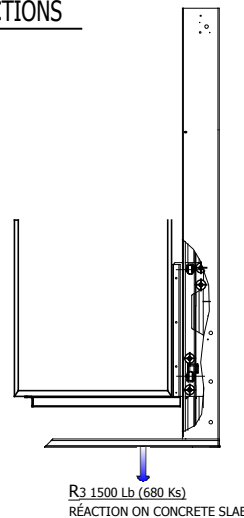

5 VISTA 750 Lb REACTIONS

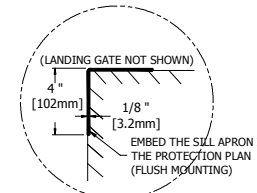

4 DETAIL C

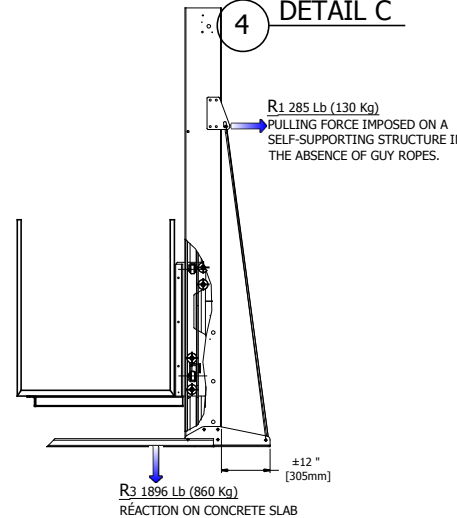

6 VISTA 1000 Lb REACTIONS

VISTA_613 TECHNICAL DATA	
TYPE	Outdoor use, vertical lift, open shaft
CODE	CSA/B613
MAX CAPACITY	One person a wheelchair or One person a wheelchair and one helper
MAX LOAD	750 Lb(340 Kg)
RAIL LINEAR WEIGHT	5 Lb/ft
TRACTION MACHINE	Acme screw and nut
ALIMENTATION	DC, 24 VOLT
VELOCITY	9 pi/min(0.05m/s) *option max speed: 14pi/min(0.07m/s)
MAX TRAVEL	98po (2500 mm) max.
EMERGENCY BRAKES	Bronze safety nut
FINI DE LA CABINE	See document C-01
CABINE	Max floor dimensions 40x66po (1018mm x1679mm)
FINI DU PLANCHER	Anti-skid floor surface
CONTROL BUTTONS	Weatherproof control buttons
CONTOLEUR	BECVIS23 (CSA/LR45147)
DOOR INTERLOCK	HONEYWELL (RELIALIGN) or GAL (TYPE N)

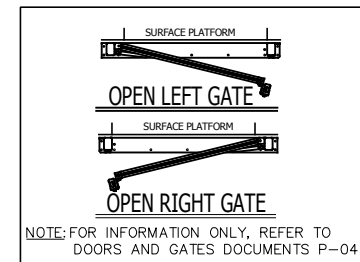

- NOTE**
- THIS ELECTRONIC DOCUMENT IS NOT SIGNED OR SEALED BY AN ENGINEER AND MAY NOT BE USED FOR CONSTRUCTION PURPOSES.
 - THIS ELECTRONIC DOCUMENT IS STRICTLY FOR INFORMATION PURPOSES (OR COORDINATION, AS APPLICABLE).
 - NO GUARANTEES ARE GIVEN ON THE INTEGRITY OF THE TRANSMITTED INFORMATION.
 - NO GUARANTEES ARE GIVEN ABOUT PAST OR FUTURE CHANGES TO THIS DOCUMENT

Les Escalateurs Atlas Inc.

8255 Boul. Laframboise
St-Hyacinthe (Québec)
J2R 1E8, Canada
Tél: (450) 796-5708
Fax: (450) 796-5110

GÉNÉRALES INFORMATIONS		
No. DRAWING	DATE:	REVISION
VISTA_AB	28/01/2016	
CODE:	DRAFTER:	No SHEET:
B355	M. Debusschere	1/1